

/C OME _____

/ E IE PE L

/DE C IP ION _____

/ P.N. _____

P	OH OH	EACH EACH	H
			:

/	/ ()
	(,)
/	
/	
/	



TRX 特锐祥
专注电容器廿年

	SMD- 1 SMD 1 . .		
	/N		/D
	/E		/P

1.





1 02 K

2

/P

2023099
C99

 TRX 专注电容器廿年	SMD- 1		
	SMD 1 . .		
	/N		/D
/E		/P	

/E	
	
	
	
	
	

3. /D

↓									
↓									
			↓						
			↓						



/N

SMD- 1
SMD 1 . .

 TRX 专注电容器廿年	SMD- 1		
	SMD 1 . .		
	/N		/D
/E		/P	

/

/

7. /P





SMD- 1
SMD 1 . .

/N		/D	
/E		/P	

 TRX 专注电容器廿年	SMD- 1		
	SMD 1 . .		
	/N		/D
/E		/P	

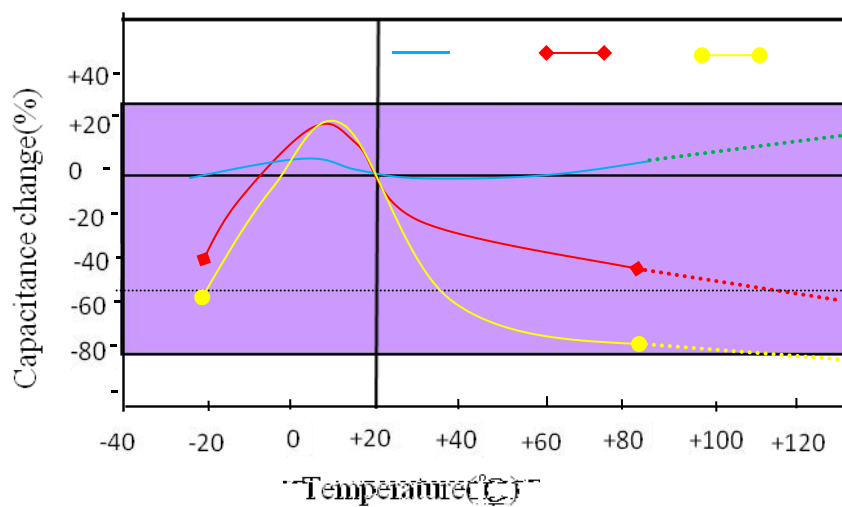
8. /C



 TRX 专注电容器廿年	SMD- 1 SMD 1 . .		
	/N		/D
	/E		/P

9.

/C

R HS H.F.
REACH

10.

/S

/

/

11. /P

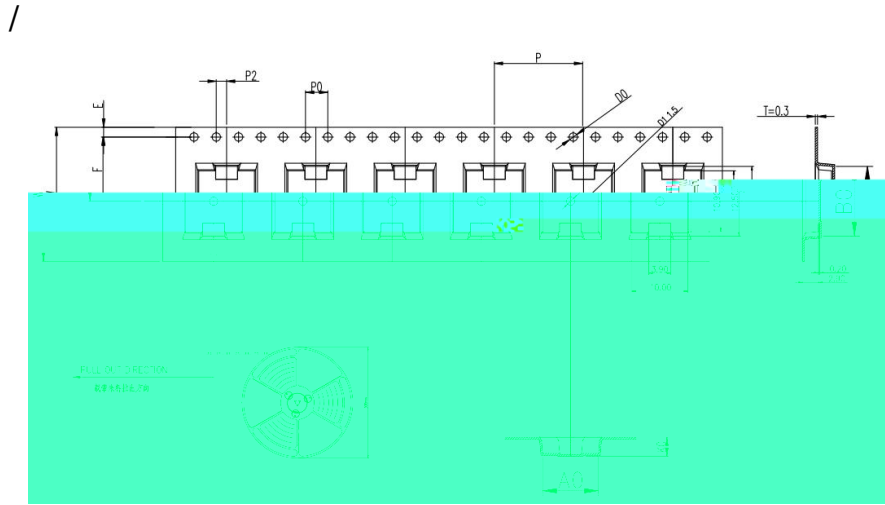

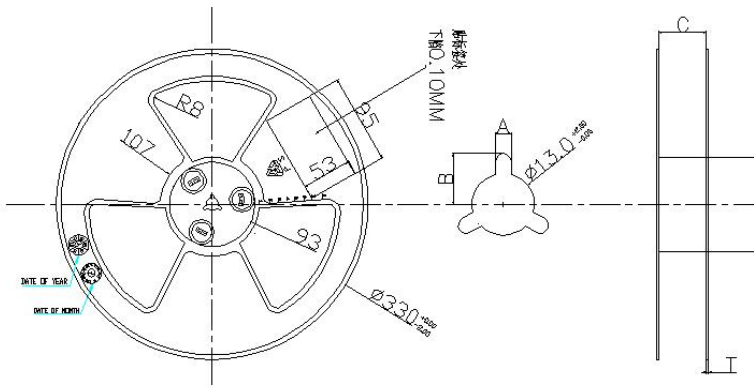

ITEM	W	A0	B0	K1	K0	P	F	E	D0	D1	P0	P2	T
DIM	24.0	$^{+0.30}_{-0.30}$	$^{+0.10}_{-0.10}$	$^{+0.10}_{-0.10}$	3.45	$^{+0.10}_{-0.10}$	$^{+0.10}_{-0.10}$	1.75	$^{+0.10}_{-0.10}$	$^{+0.10}_{-0.10}$	$^{+0.10}_{-0.10}$	$^{+0.10}_{-0.10}$	$^{+0.05}_{-0.05}$
ALTERNATE													

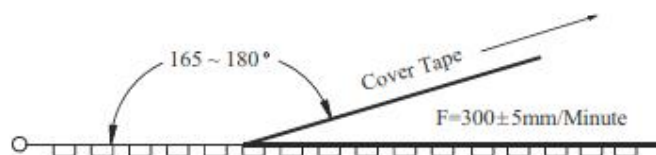

SPEC	A±0.3	B±0.5	C $^{+0.5}_{-0.0}$	D±0.5	T±0.2
24	2.3	10.75	24.4	Ø97	2.2

Item	Data	Remark
Cover tape adhesion	10 ~ 100g	Carrier tape and cover tape open angle 165 ~ 180° F=300± 5mm/minute



 TRX 专注电容器廿年	SMD- 1		
	SMD 1 . .		
	/N		/D
/E		/P	

/ -













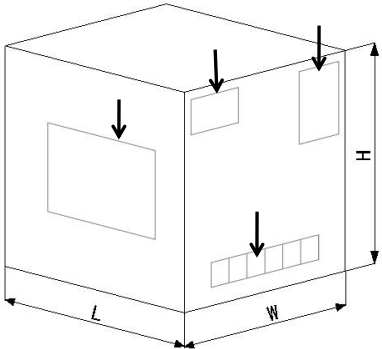

/O -









/P :









R

