

S

JAENS	
SUNN	



TRX 特锐祥
专注电容器十年

 TRX 专注电容器廿年	SMD- 1			
	SMD 1 . .			
	/N		/D	
/E		/P		

/ I

/ II

TR SMD- 1.CAP

C R T.C D (: F

T.C						

	SMD- 1 SMD 1 . .		
	/N		/D
	/E		/P

 TRX 专注电容器廿年	SMD- 1 SMD 1 . .		
	/N		/D
	/E		/P





1. /P N

T G _1 102 K

2. /P

	
--	--

	SMD- 1 SMD 1 . .		
	/N		/D
	/E		/P

/E	
	
	
	
	
	

3. /D

↓	↓				
		↓	↓		



SMD- 1
SMD 1 . .

/N

 TRX 专注电容器廿年	SMD- 1		
	SMD 1 . .		
	/N		/D
/E		/P	

/

/

7. /P

	SMD- 1		
	SMD 1 . .		
	/N		/D
	/E		/P

	SMD- 1 SMD 1 . .			
	/N		/D	
	/E		/P	

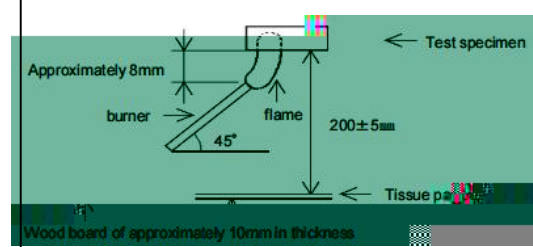
 TRX 专注电容器廿年	SMD- 1		
	SMD 1 . .		
	/N		/D
	/E		/P

8. /C



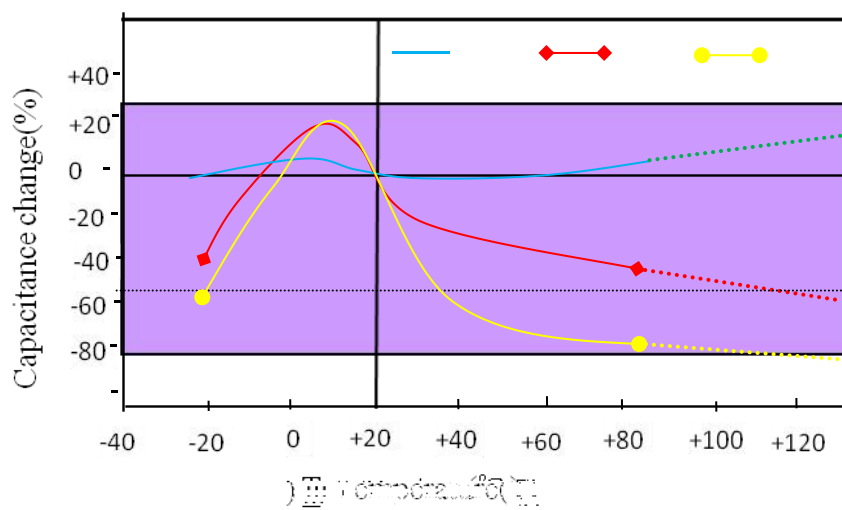

SMD- 1
SMD 1 . .

/N		/D	
/E		/P	

9. /C

R HS H.F.
REACH

10. /S

/

11. /P
/

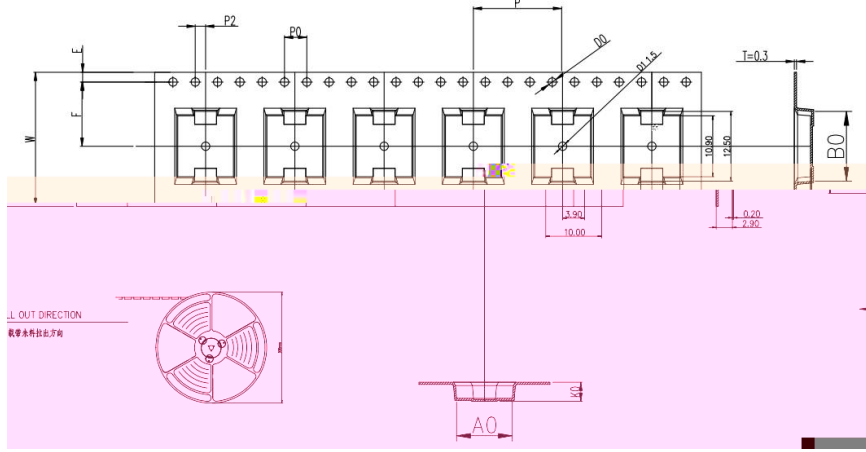

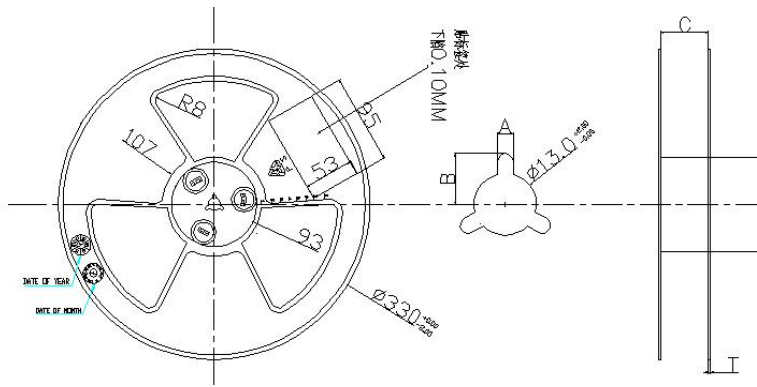

ITEM	W	A0	B0	K1	K0	P	F	E	D0	D1	P0	P2	T														
DIM	24.0	$^{+0.30}_{-0.30}$	$^{+0.10}_{-0.10}$	$^{+0.10}_{-0.10}$	$^{+0.10}_{-0.10}$	3.45	$^{+0.10}_{-0.10}$	16.0	$^{+0.10}_{-0.10}$	11.50	$^{+0.10}_{-0.10}$	1.75	$^{+0.10}_{-0.10}$	10.00	$^{+0.20}_{-0.20}$	10.00	$^{+0.20}_{-0.20}$	12.50	$^{+0.30}_{-0.30}$	10.00	$^{+0.10}_{-0.10}$	4.0	$^{+0.10}_{-0.10}$	2.0	$^{+0.10}_{-0.10}$	0.30	$^{+0.05}_{-0.05}$

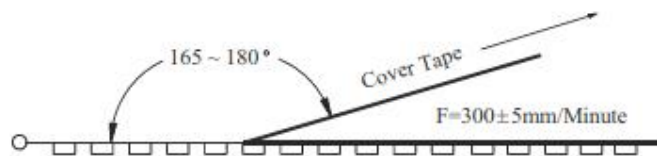

SPEC	A±0.3	B±0.5	C $^{+0.5}_{-0.0}$	D±0.5	T±0.2
24	2.3	10.75	24.4	Ø97	2.2

Item	Data	Remark
Cover tape adhesion	10 ~ 100g	Carrier tape and cover tape open angle 165 ~ 180° F=300± 5mm/minute



 TRX 专注电容器廿年	SMD- 1 SMD 1 . .		
	/N		/D
	/E		/P

/ -

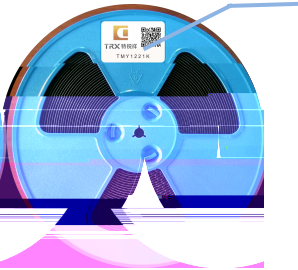



TRX 特锐祥
TGY1102K

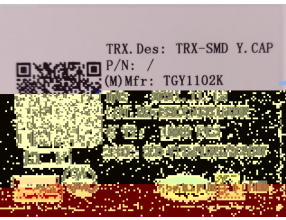



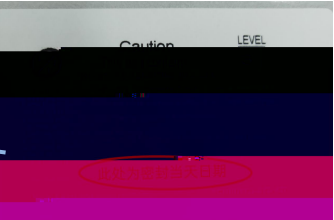

TRX Des: TRX-SMD Y. CAP
P/N: /
(M) Mfr: TGY1102K



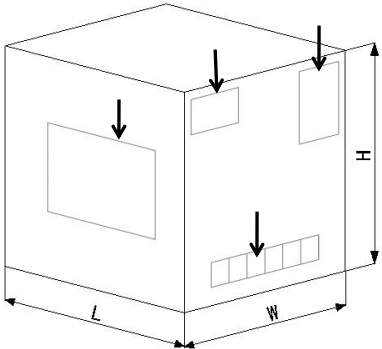

/O -









/
/
/

/P :









/
/

R

	SMD- 1 SMD 1 . .		
	/N		/D
	/E		/P

12. /A