

性能双引脚同步整流芯片

产品概

DK5V1 R1 SL
A K

PN

1 V NM S

典型应用

- USB
-
- LED

DK5V1 R1 SL T -252

主要特点

- PSR SSR
- V_F
-
- 1 V 1 mΩ NM S
- CCM DCM QR&
-
-
- EMC
-

引出端排列

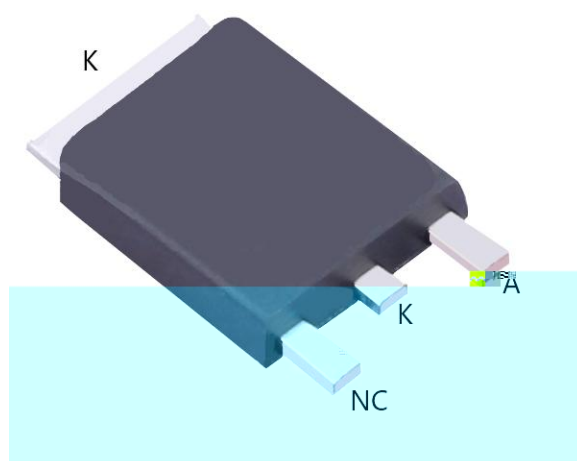

引出端功能

Pin No.	Pin Name	Function
1	NC	No Connection
2	K	Cathode
3	A	Anode

典型功率

备注:

典型功率在密 45°C环境下测试, DK5V1 R1 SL 系统 出 定电流建议不超 4.3A.

电路结构方框图

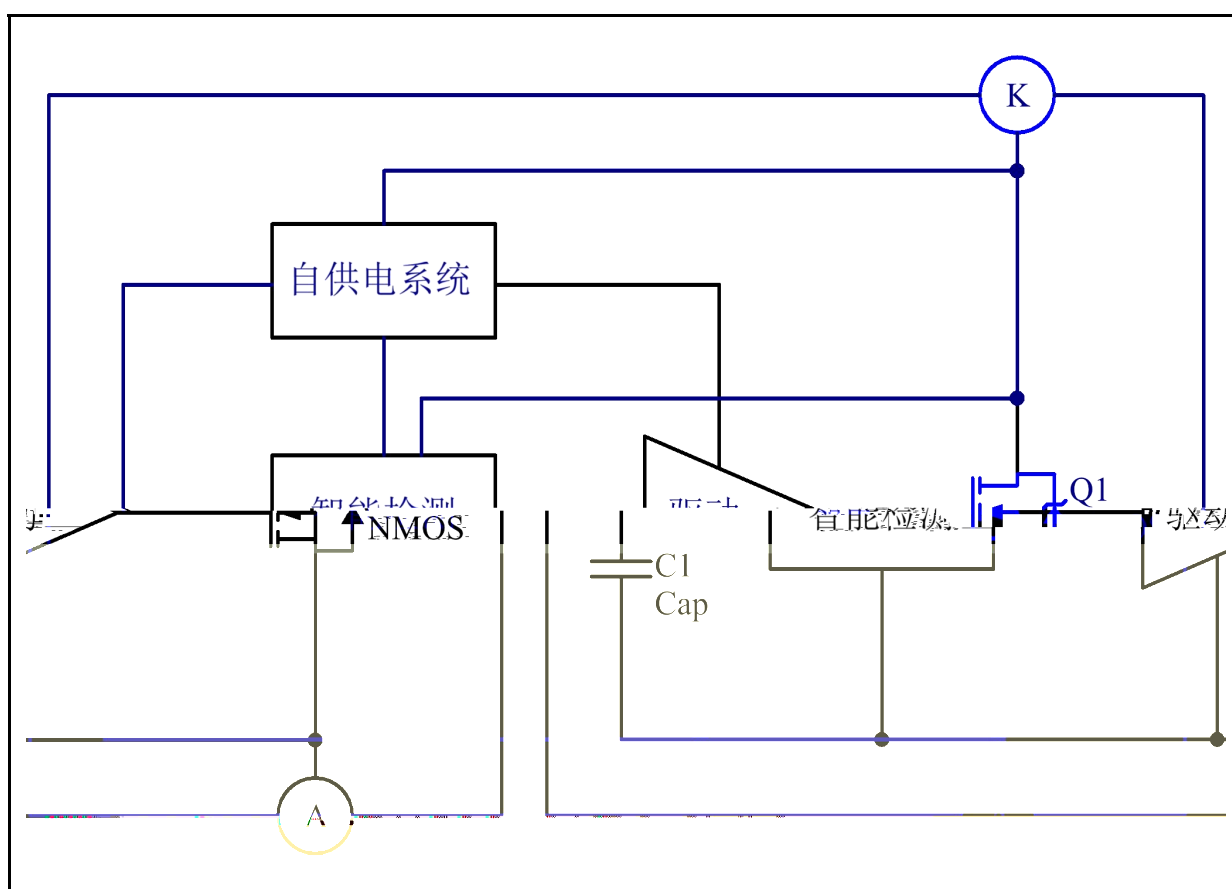

极 参数

NM S	$V_{(BR)DSS}$	1			V
NM S	I_{DSCDC}			5	A
NM S	I_{DSPDC}			65	A
T 252	P_{DMAX}		11		W
	R_{JA}		9		/W
	R_{JC}		1.3		/W
	T_{STG}	-55		155	
	T_J	-4		15	
			26 /5S		
ESD(HBM)			4		V
ESD(MM)			35		V

电特性参数 ($T_A = 25$ 有其他说明)

①	V_{CC_N}			5.6		V
①	V_{CC_FF}			3.3		V
①	V_{VP}			8.3		V
NM S	V_N	K		-2		mV
NM S	T_{D_N}				15	ns
NM S	T_{D_FF}				5	ns
NM S	T_{N_MAX}			2		μ s
	T_D			4		ns
	F_{S_MAX}				15	KHz
NM S	R_{DS_N}				1	m Ω

①

A

K

功能描

DK5V1 R1 SL

启动

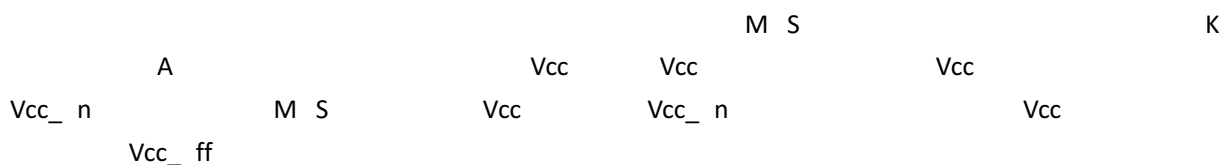

控制

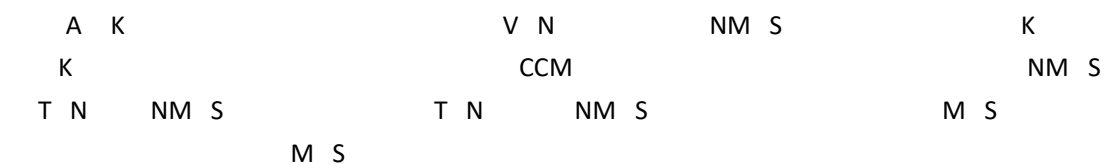

吸收电路



导内



注意事

- NM S
-

典型应用线路图

正向整流

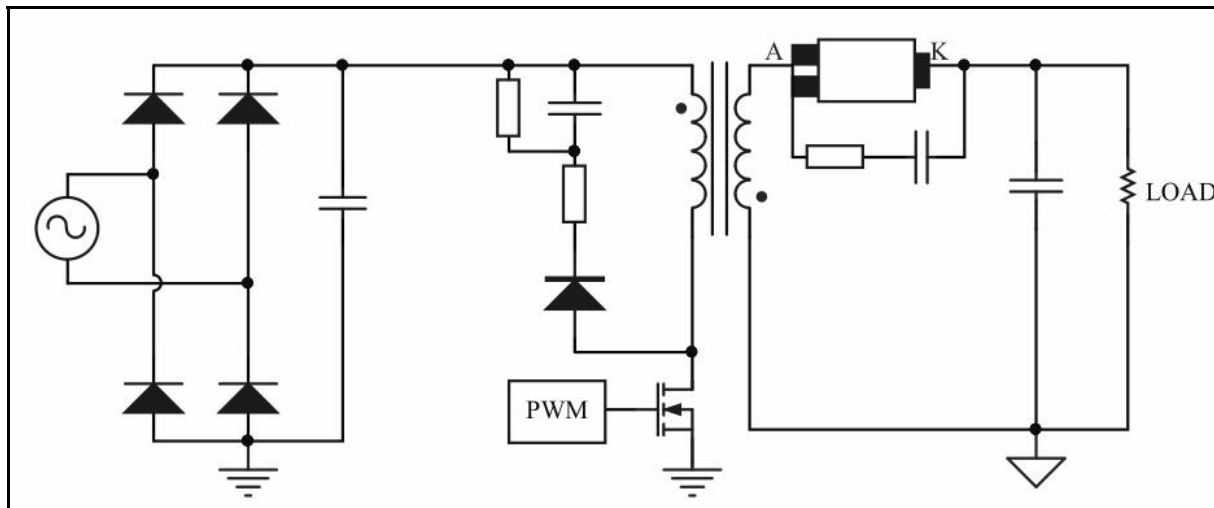

反向整流

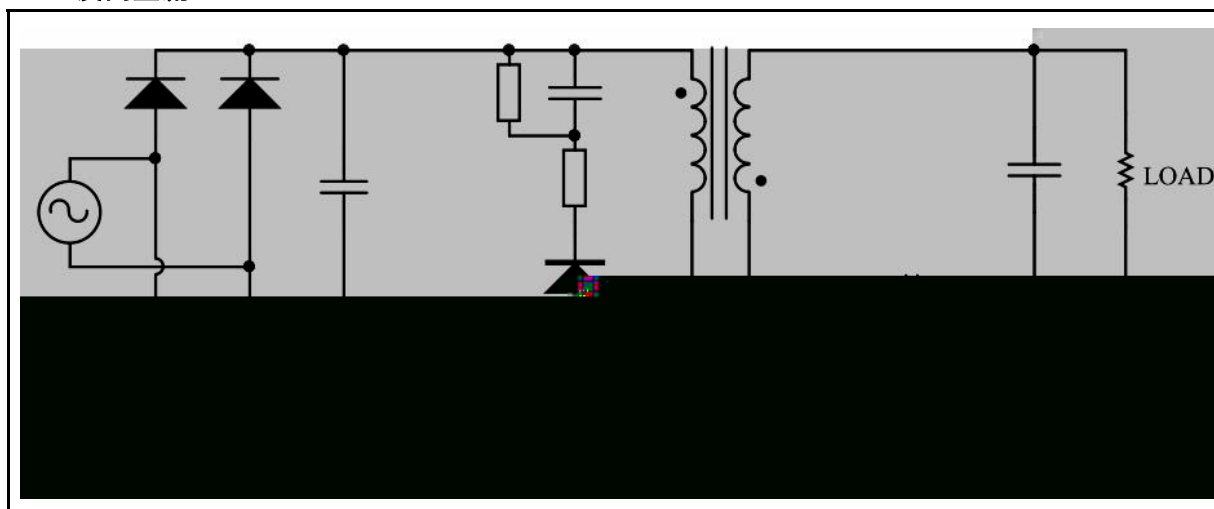

封装外形及尺寸图

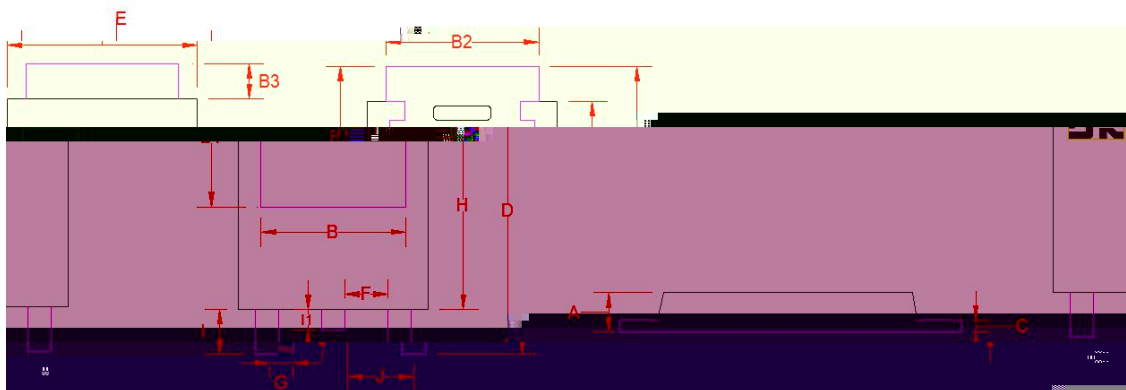

A	1.33	1.36	1.38
B	4.95	5.	5. 5
B1	4.8	4.85	4.9
B2	5.2	5.3	5.4
B3	1.1	1.2	1.3
C	.4	.42	.45
D	9.85	9.95	1 . 5
E	6.5	6.6	6.7
F	1.45	1.5	1.55
G	.75	.8	.85
H	7.1	7.2	7.3
I	1.5	1.55	1.6
l1	.65	.7	.75
J	2.3 BSC		



- ▼
- ▼
- ▼
- ▼
- ▼
- ▼
- ▼

- ▼