



深圳市弗瑞鑫电子有限公司

规格承认书

—

prepare	
check	
approve	



TRX 特锐祥
特锐祥 特锐祥 特锐祥 11 年

TRX电容一级代理商

深圳市弗瑞鑫电子有限公司

Add: 深圳市宝安区西乡大道302号金源商务大厦B座3楼
Tel: 0755-29563634
Fax: 0755-27447020

 TRX 专注电容器廿年	SMD- 2			
	SMD 2 . .			
	/N	-3-082	/D	2021-11-15
	/E	A1	/P	P 3 18

1/ I

/

CODE	C OME P.N.	P.N.	P	P
1	/	B 2220K L	MD- 2 L220K/AC300	4335
2	/	B 2470K L	MD- 2 L470K/AC300	4335
3	/	B 2680KB	MD- 2 5P680K/AC300	4335
4	/	B 2101KB	MD- 2 5P101K/AC300	4335
5	/	B 2221KB	MD- 2 5P221K/AC300	4335
6	/	B 2331KB	MD- 2 5P331K/AC300	4335
7	/	B 2471ME	MD- 2 5 471M/AC300	4335
8	/	B 2681ME	MD- 2 5 681M/AC300	4335
9	/	B 2102ME	MD- 2 5 102M/AC300	4335
10	/	B 2152MF	MD- 2 5 152M/AC300	4335
11	/	B 2222MF	MD- 2 5 222M/AC300	4335
		L CLA I	5P/ 5 / 5	CLA II

2/ II

TRX SMD- 2.CAP

C R T.C D

U : F

2

2 AC

.C	22	47	68	100	220	330	470	680	1000	1500	2200
L											
2B(5P)											
2E(5)											
2F(5)											
	300 .										
o	-40 125										
C	40/ 125/ 21										

1000

100H

A AC

:

..

1000 . ,

..

100H .

 TRX 专注电容器廿年	SMD- 2			
	SMD 2 . .			
	/N	-3-082	/D	2021-11-15
	/E	A1	/P	P 4 18

/CON EN

1.	P	N		5
2.	P			5-6
3.	D			6
4.	C			7
5.	P			7-8
6.				8-9
7.	P			9-14
8.	C			14
9.	C			15
10.				15
11.	P	P		16-17
12.	A			18

	SMD- 2			
	SMD 2 . .			
	/N	-3-082	/D	2021-11-15
	/E	A1	/P	P 5 18

1. /P N

T B 2 102 M E
 ① ② ③ ④ ⑤ ⑥

N . C

E

①

L

 TRX 专注电容器廿年	SMD- 2		
	SMD 2 . .		
	/N	-3-082	/D
/E	A1	/P	P 6 18

3. /D



		2020	M	1	01	1	01	16	16
		2021	N	2	02	2	02	17	17
2010	A	2022	P	3	03	3	03	18	18
2011	B	2023		4	04	4	04	19	19
2012	C	2024		5	05	5	05	20	20
2013	D	2025		6	06	6	06	21	21
2014	E	2026		7	07	7	07	22	22
2015	F	2027		8	08	8	08	23	23
2016	H	2028		9	09	9	09	24	24
2017	J	2029		10	10	10	10		

 TRX 专注电容器廿年	SMD- 2			
	SMD 2 . .			
	/N	-3-082	/D	2021-11-15
/E	A1	/P	P 7 18	

4. /C

C		C	C
L/C L	L/C A 60384-14	E315719	AC300 (. . .)
C C	GB/ 6346.14-2015	C C20001280609	AC300 (. . .)
ENEC	EN 60384-14:2013/A1:2016	ENEC-03177	AC300 (. . .)
KC	K60384-14	H 03034-21003A	AC250 (. . .)

5. /P

5.1 /P D

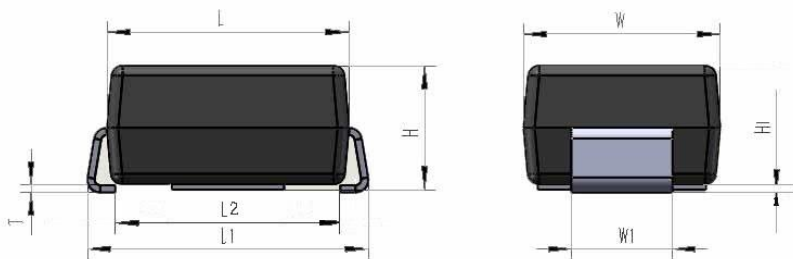

P		D		()	
L	4.3 0.1			3.5 0.3	
L1	5.0 0.1	L2		4.0 0.1	
H	2.2 0.1	1		1.8 0.05	
H1	0.1 0.05			0.13 0.02	

5.2 /P

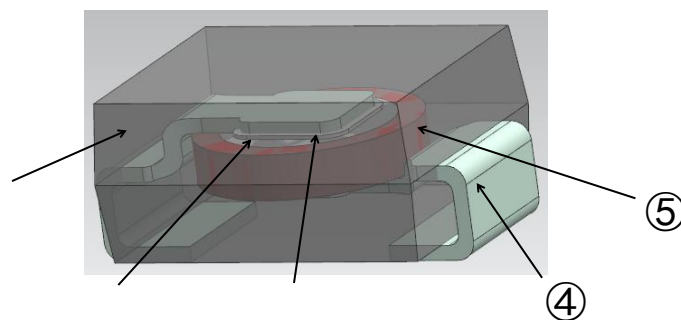

N .	P	M
①	C	(L94 -0) E (L94 -0)
②	E	/C
③		-P -A -P -A
④	L P	
⑤	D	C

SMD- 2

SMD 2 . .

/N

-3-082

/D

2021-11-15

/E

 TRX 专注电容器廿年	SMD- 2			
	SMD 2 . .			
	/N	-3-082	/D	2021-11-15
	/E	A1	/P	P 9 18

6.2 /F

280 °
280°C

30 °
30

200 °
200

P 200

180 °
180

P 180

6.3 / I
PCB/P B

PCB/P B,

400
- 400

50
50

5
5

7. /P

NO	I		
1	A	N L L	
2	D	5.1 5.1	

 TRX 专注电容器廿年	SMD- 2		
	SMD 2 . .		
	/N	-3-082	/D
/E	A1	/P	P 10 18

NO	I	
----	---	--

3 MA

 TRX 专注电容器廿年	SMD- 2			
	SMD 2 . .			
	/N	-3-082	/D	2021-11-15
	/E	A1	/P	P 11 18

NO	I			
8				150 180 C 90 30 P 150 180 C 90 30 . / : 230 C-260 C / : 60± 15 . / :4 15--35 45--75% H 24 2 L 15-35 , 45-75% H 24 2 , .
		NO.3 P NO.3		
	C	L:± 10% 5P:± 10% 5 :± 20% 5 :± 20%		
	D.F.	L: 1.0% 5P: 2.5% 5 : 2.5% 5 : 2.5%		
	I .	NO.7 P NO.7		
9				(JI K 5902) (JI K 8101) (25%) () I (90%) 3 5902) (25%) (JI K 8101) (JI K) . () I 2 0.5 2 0.5 . : 245 10 C
10		N		
		NO.3 P NO.3		: +125 3
	C	L:± 10% 5P: 10% 5 : 20% 5 : 20%		: -40 3 / :5
	D.F.	L: 1.0% 5P: 2.5% 5 : 2.5% 5 : 2.5%		30 25 3 24 2
	I .	NO.7 P NO.7		C 24 2 25 3 .

SMD- 2
SMD

 TRX 专注电容器廿年	SMD- 2 SMD 2 . .			
	/N	-3-082	/D	2021-11-15
	/E	A1	/P	P 14 18

NO	I		
16	C	N NO.3 NO.7 P N .3 N .7	$30 \pm 5\%$ $70 \pm 5\%$ $30 \pm 5\%$ $70 \pm 5\%$ / 23.5 5 ± 0.5 $5.0.5$ / 8
17			$30 \pm 5\%$ $70 \pm 5\%$ $30 \pm 5\%$ $70 \pm 5\%$ / 23.5 5 ± 0.5 10 $5.0.5$ 10

8. /C

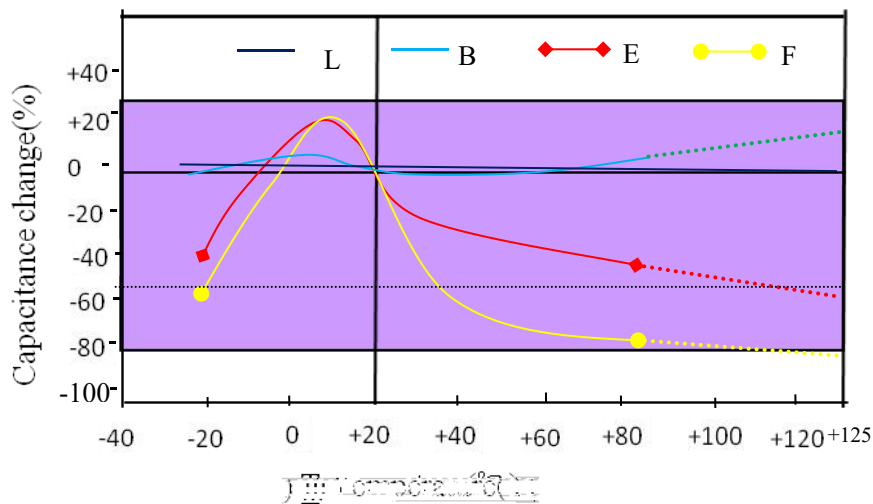

 TRX 专注电容器廿年	SMD- 2			
	SMD 2 . .			
	/N	-3-082	/D	2021-11-15
/E	A1	/P	P 15 18	

9. /C

H 2.0 2011/65/E

EACH N 190 7/2006



	(;)
/C	<100
/L	<1000
/M	<1000
/H	<1000
PBB /P	<1000
PBDE /P	<1000
+ + + /C +P +H +C +6()	<100
/C	<900
/B	<900
+ /C +B	<1500
EACH HC (HC) EACH	EACH

10. /S

(1).

E ; , , , , ,
 . A , , , , , , , , , ,

(2). 12 , 12

/ : 10 30
 /H : 60%
 (3). 168

, 168 HIC - . A

(4). 6
 60 × 168
 I

, 6 HIC
 (60 168) .

 TRX 专注电容器廿年	SMD- 2		
	SMD 2 . .		
	/N	-3-082	/D
/E	A1	/P	P 16 18

11. /P P

11.1 /D

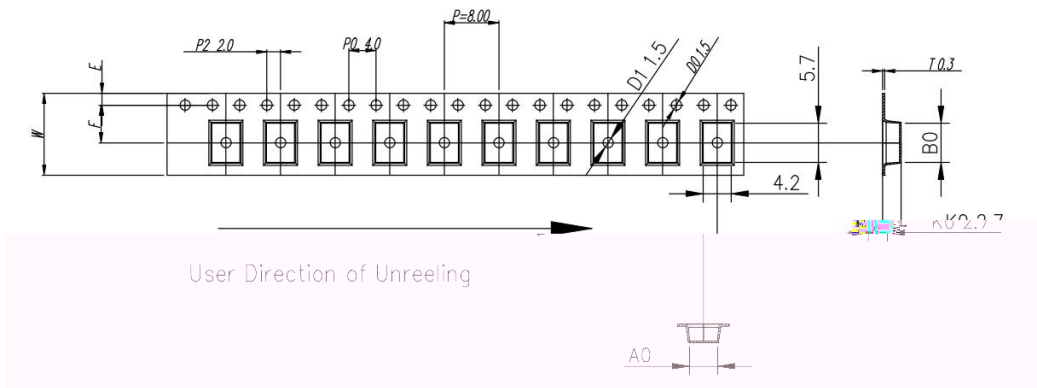

ITEM	W	A0	B0	K1	K0	P	F	E	D0	D1	P0	P2	T
DIM	12.0 ±0.30	4.2 ±0.10	5.70 ±0.10	--	2.70 ±0.10	8.00 ±0.10	5.50 ±0.10	1.75 ±0.10	1.5 ±0.00	1.5 ±0.10	4.0 ±0.10	2.0 ±0.10	0.30 ±0.05
ALTERNATE													

11.2 /D

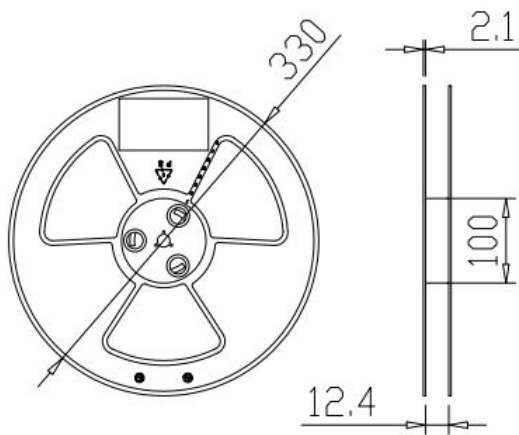

EEL	EEL I E
3000	13

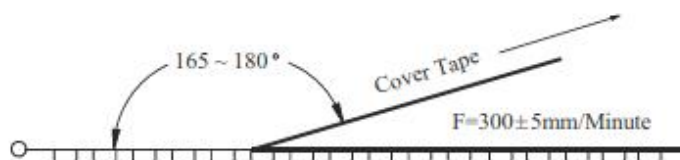

11.3 /P

Item	Data	Remark
Cover tape adhesion	10 ~ 100g	Carrier tape and cover tape open angle 165 ~ 180° F=300± 5mm/minute



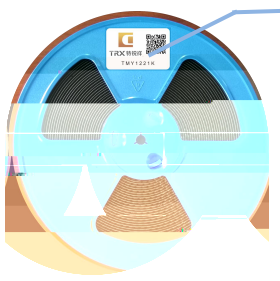

 TRX 专注电容器廿年	SMD- 2			
	SMD 2 . .			
	/N	-3-082	/D	2021-11-15
/E	A1	/P	P 17 18	

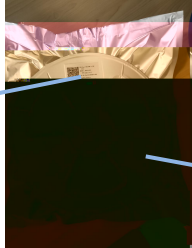
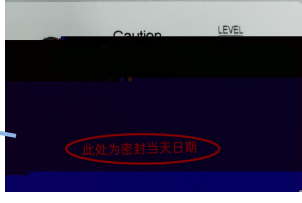

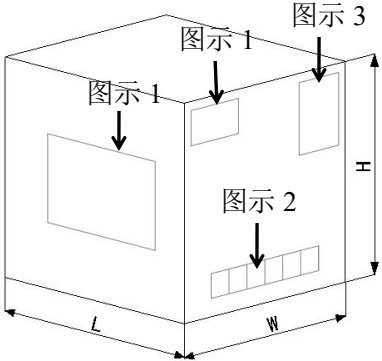

11.4 /P P

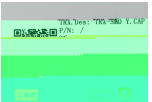
/ -	 标签/L  料号  		/I
/ : 13 3.0KPC /			.D
			P/N
			M
			D/C
			L .N
			PEC
/P	/L	/H	

/O -

			
图示 1/F 1	图示 2/F 2	图示 3/F 3	
D ()			O B
L	H	45KPC	10.0KG
355	358	294	

/P :

			
/O B	15 / /15 /B	(/ /) P (L/ /H) 1100*1100*90	(/ /) (L/ /H) 1100*1100*1600

1. " 5" 5 2. PALLE & APPING
 3.50 R :1. 5 4. / ' 5 ; 2. P & -
 ; 3.50 ; 4. N

	SMD- 2			
	SMD 2 . .			
	/N	-3-082	/D	2021-11-15
	/E	A1	/P	P 18 18

12. /A

①.

A

②.

PCB

PCB

PCB

C