

## IGBT Modules

VCES

IC

Applications

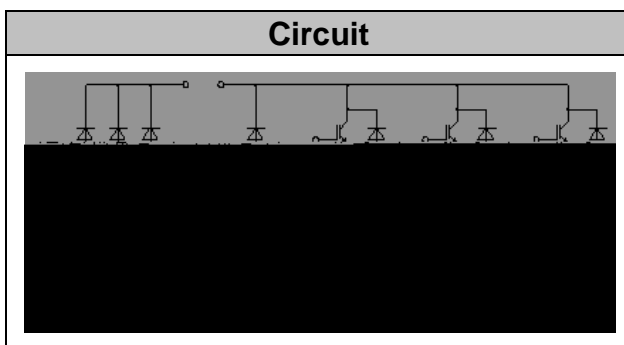

### Features

- 
- 
- 
- 
- 
- 
- 

### IGBT- inverter

#### Absolute Maximum Ratings

Parameter	Symbol	Conditions	Value	Unit





## Diode-inverter Absolute Maximum Ratings

Parameter	Symbol	Conditions	Value	Unit

## Characteristic values

Parameter	Symbol	Conditions	Value			Unit
			Min.	Typ.	Max.	





**Diode-Brake-Chopper  
Absolute Maximum Ratings**

Parameter	Symbol	Conditions	Value	Unit

**Characteristic values**

Parameter	Symbol	Conditions	Value			Unit
			Min.	Typ.	Max.	



## Diode-Rectifier Absolute Maximum Ratings

Parameter	Symbol	Conditions	Value	Unit

## Characteristic values

Parameter	Symbol	Conditions	Value			Unit
			Min.	Typ.	Max.	

## NTC-Thermistor Characteristic values

Parameter	Symbol	Conditions	Value			Unit
			Min.	Typ.	Max.	



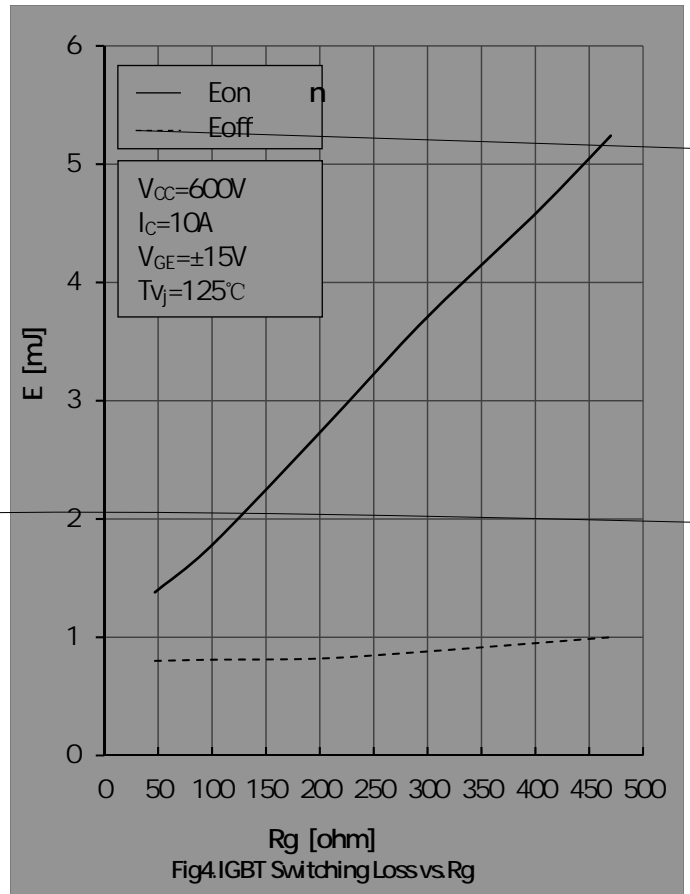
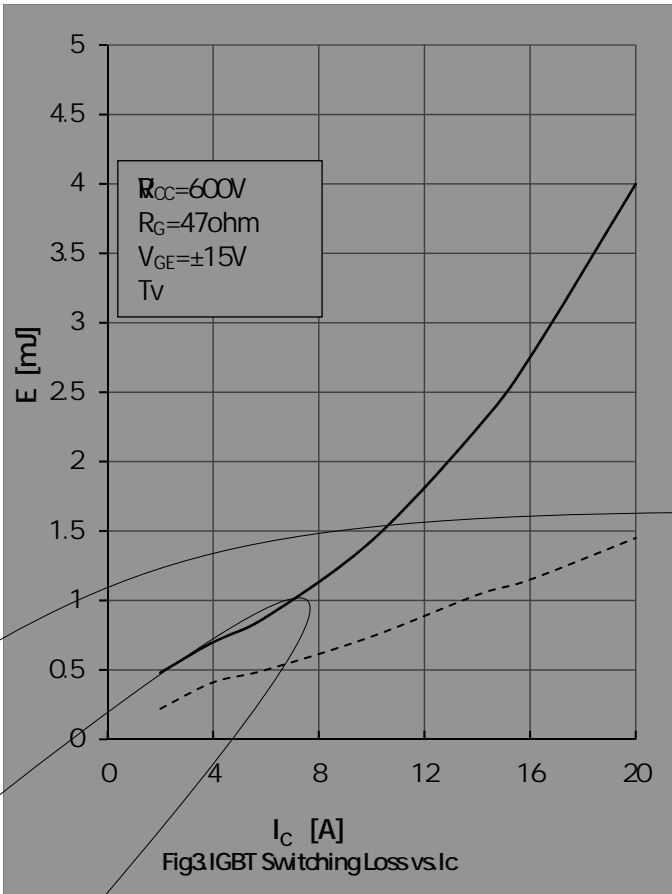
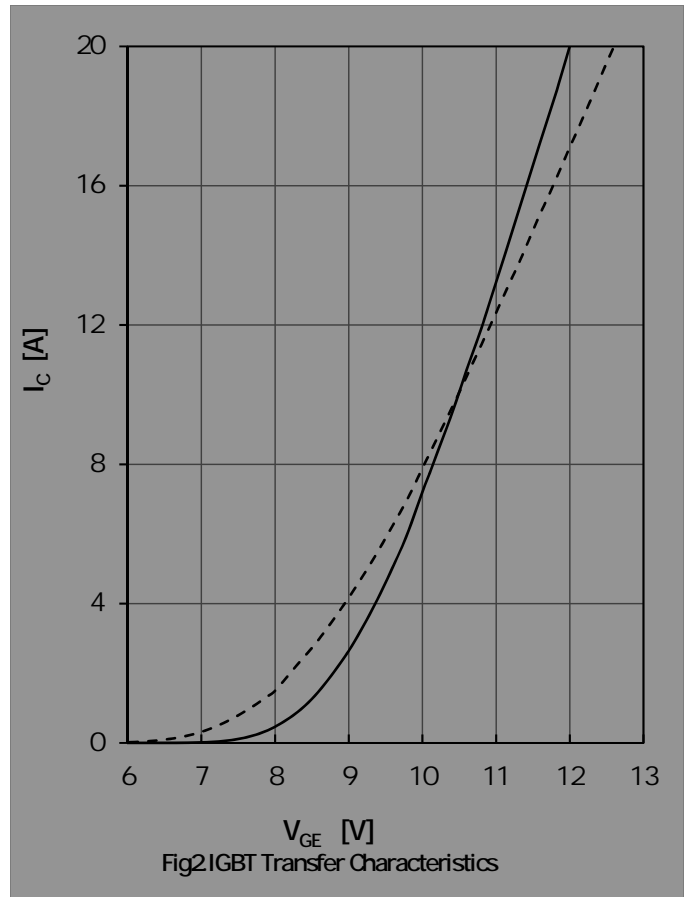
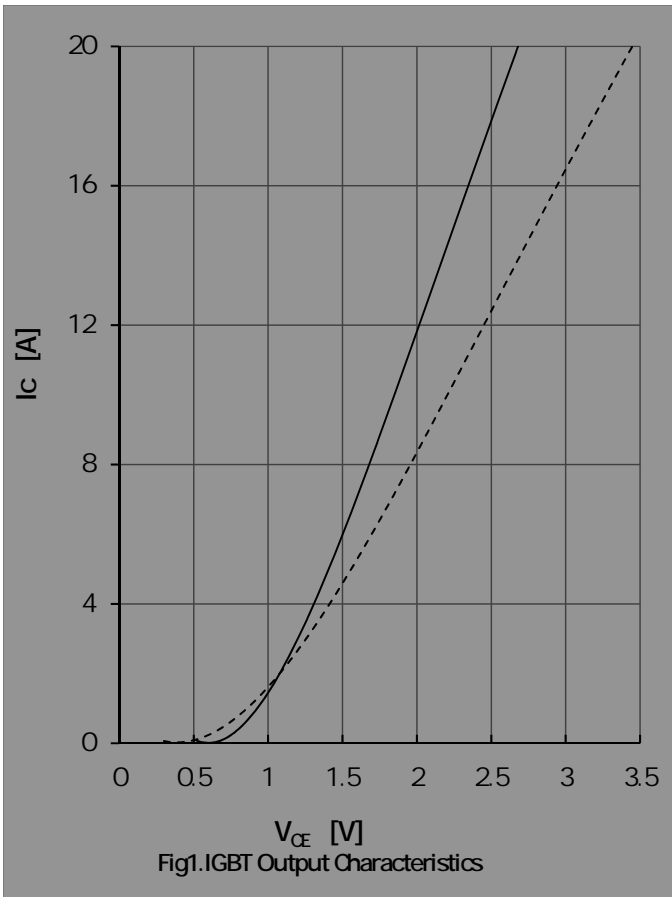



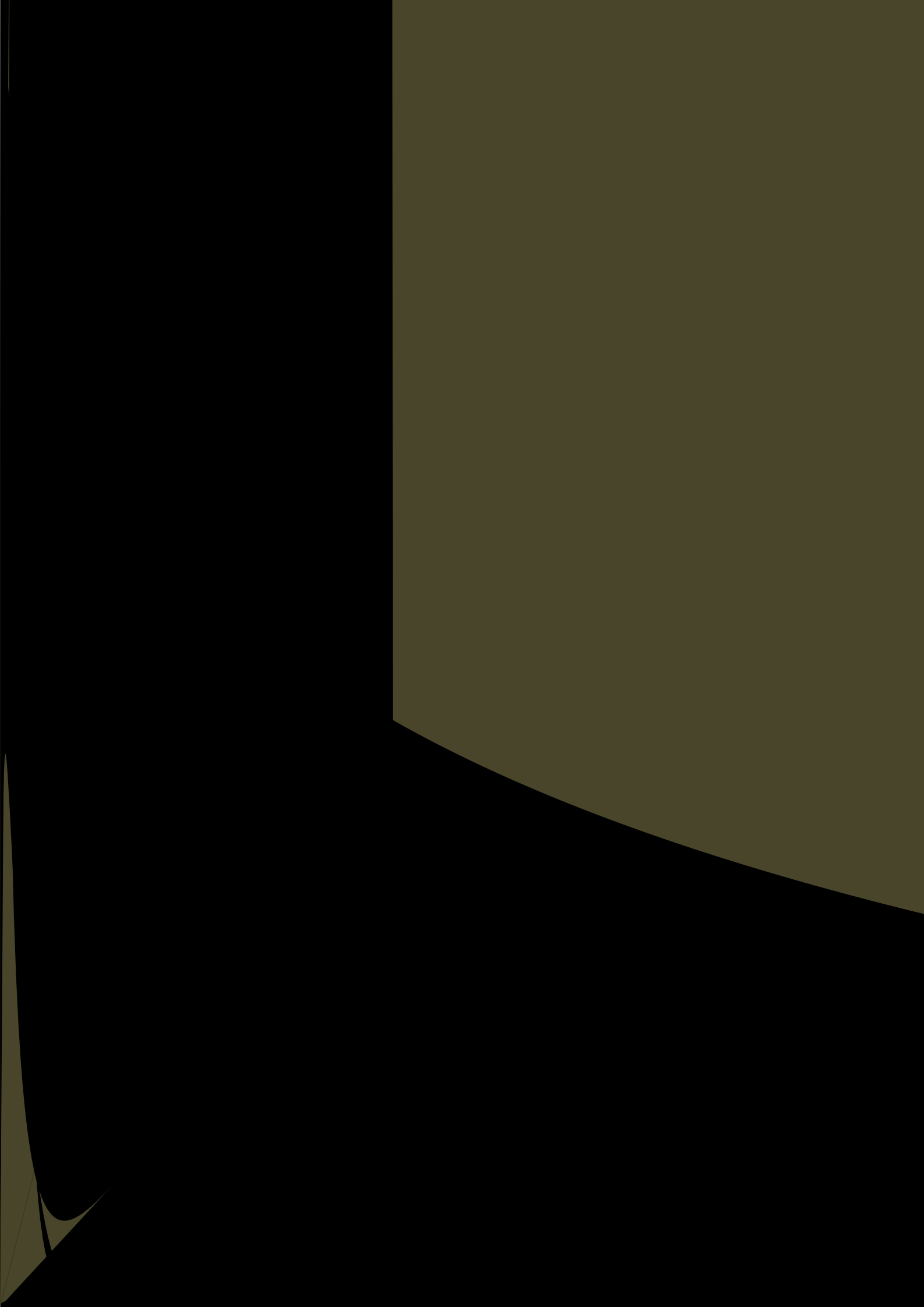

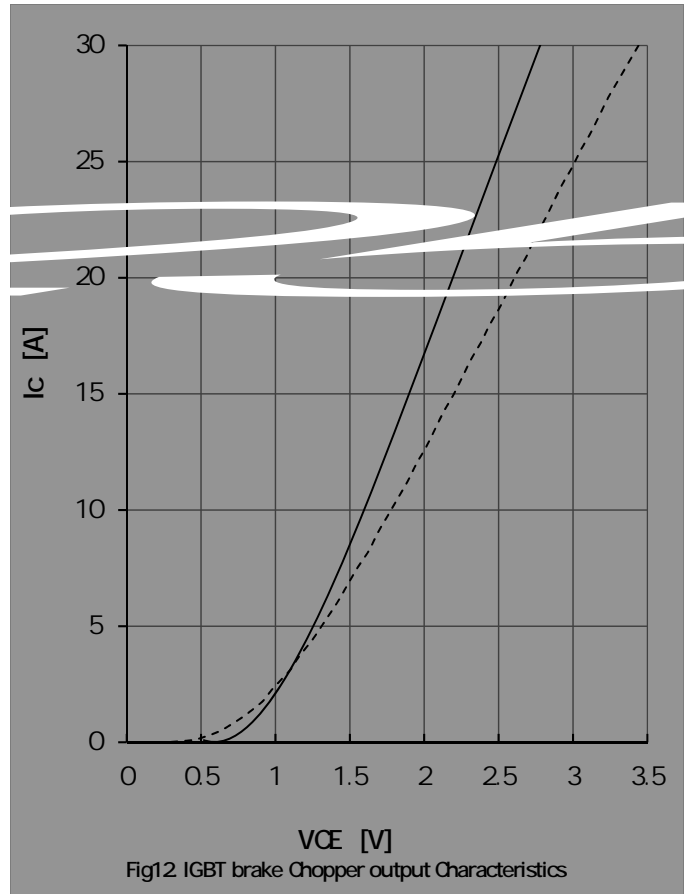
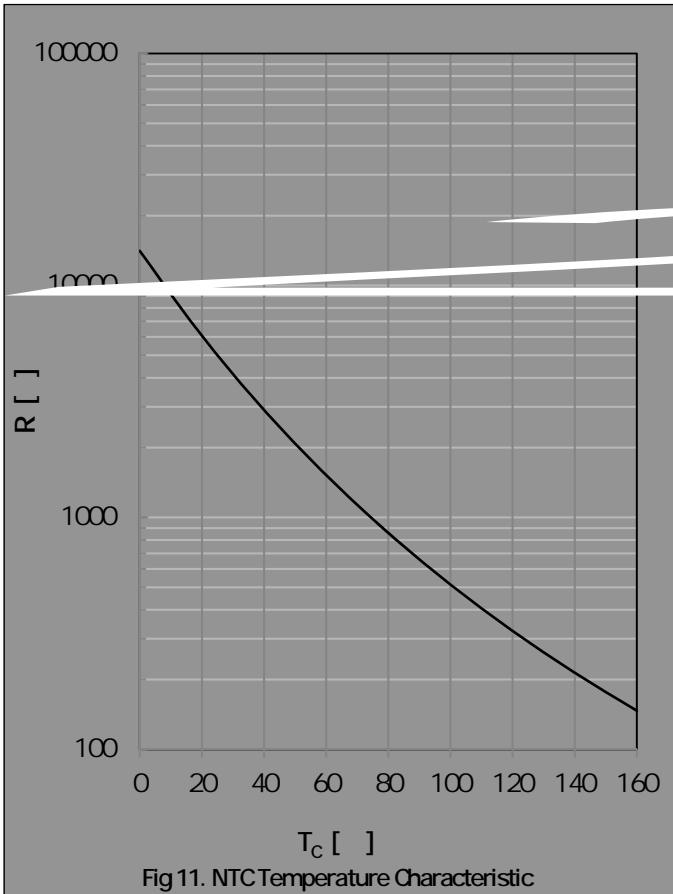
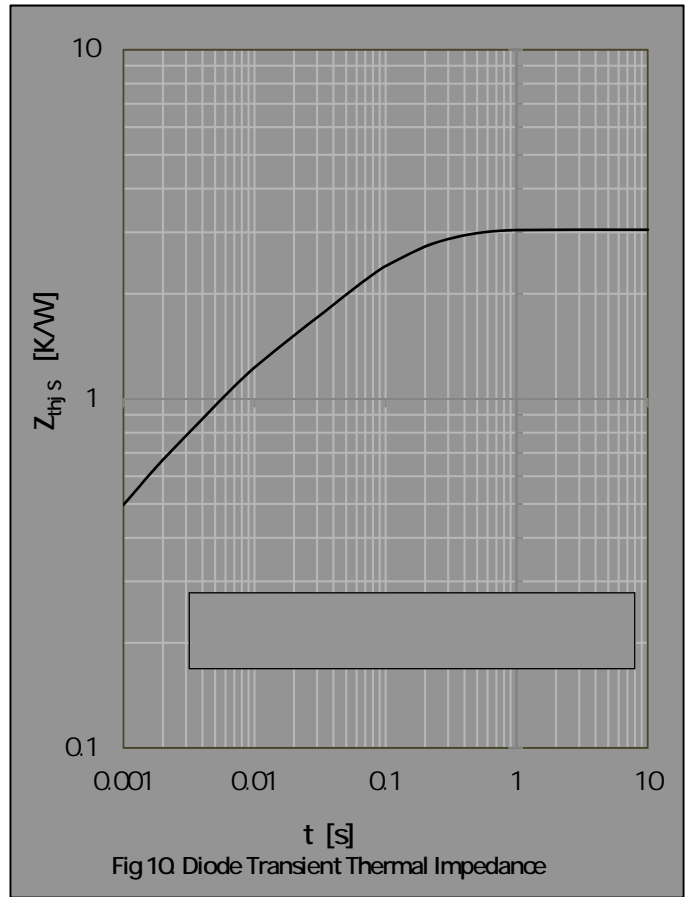
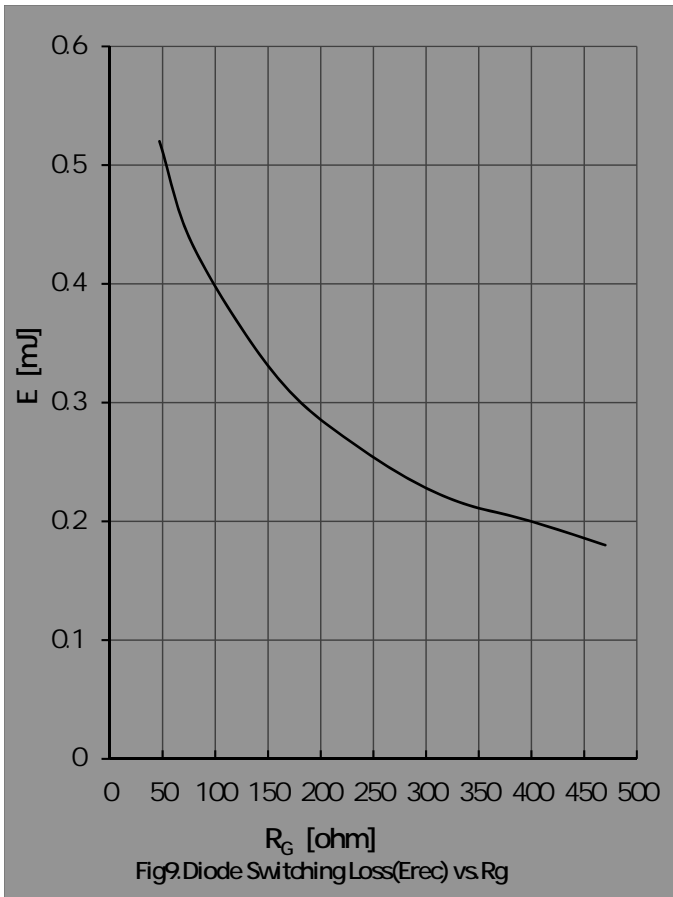

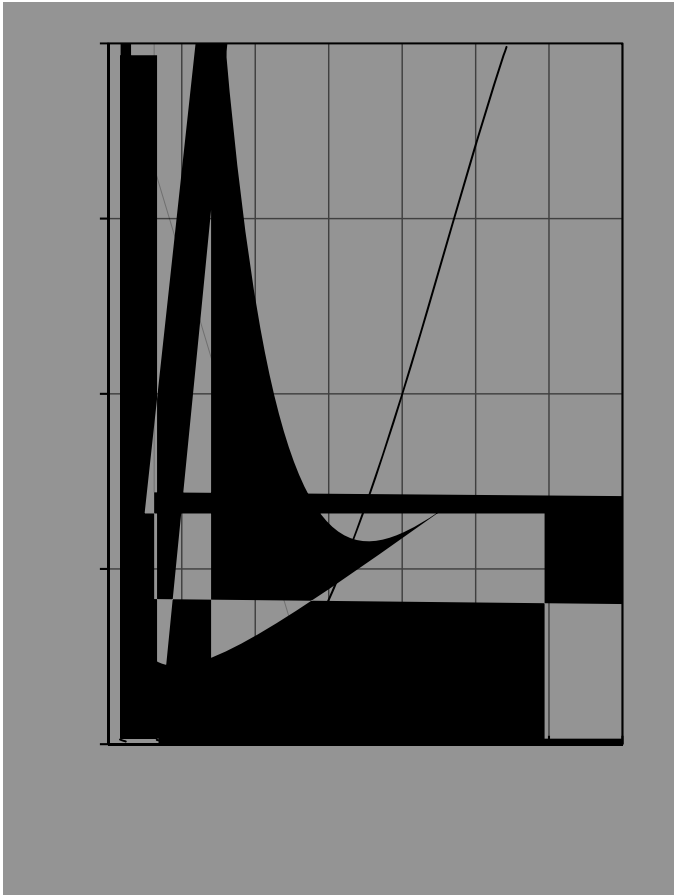



# MG10P12P2

RoHS  
COMPLIANT

## Circuit Diagram

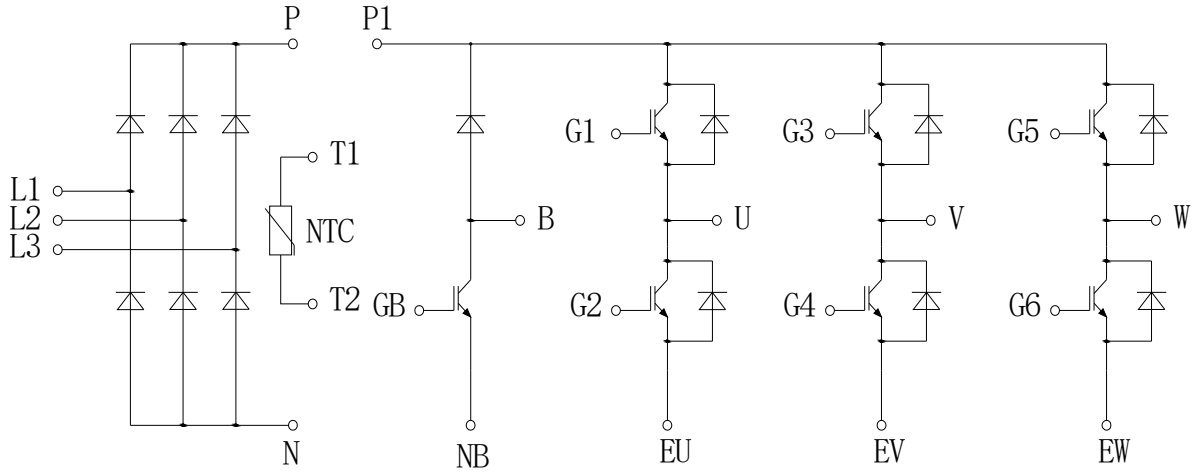

## Package Dimensions

