

## Silicon Carbide Schottky Diode

$V_{RRM}$	1200V
$I_F$ 135°C	38A
$Q_C$	153nC

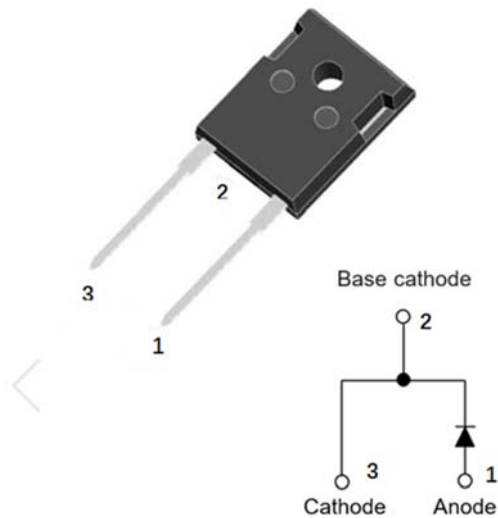

### Features

- Positive temperature coefficient
- Temperature-independent switching
- Maximum working temperature at 175 °C
- Unipolar devices and zero reverse recovery current
- Zero forward recovery current
- Essentially no switching losses
- Reduction of heat sink requirements
- High-frequency operation
- Reduction of EMI

### Typical Applications

Typical applications are in power factor correction(PFC), solar inverter, uninterruptible power supply, motor drives, photovoltaic inverter, electric car and charger.

### Mechanical Data

**Package:** TO-247AC

**Terminals:** Tin plated leads

**Polarity:** As marked

### Maximum Ratings ( $T_c=25$ Unless otherwise specified)

PARAMETER	SYMBOL	UNIT	VALUE
Device marking code			D112030NG1
Reverse voltage (repetitive peak) @ $T_j=25^\circ\text{C}$	$V_{RRM}$	V	1200
Reverse voltage (Surge Peak) @ $T_j=25^\circ\text{C}$	$V_{RSM}$	V	1200
Reverse voltage (DC) @ $T_j=25^\circ\text{C}$	$V_{DC}$	V	1200
Continuous forward current @ $T_c=25^\circ\text{C}$	$I_F$	A	81
Continuous forward current @ $T_c=135^\circ\text{C}$			38
Continuous forward current @ $T_c=149^\circ\text{C}$			30
Non-repetitive peak forward surge current @ $T_c=25^\circ\text{C}$ , $t_p=10\text{ms}$ , Half Sine Wave	$I_{FSM}$	A	240
Power Dissipation @ $T_c=25^\circ\text{C}$	$P_{TOT}$	W	394
Power Dissipation @ $T_c=110^\circ\text{C}$			171
$i^2t$ Value @ $T_c=25^\circ\text{C}$ , $t_p=10\text{ms}$	$i^2t$	$\text{A}^2\text{S}$	288
Operating junction and Storage temperature range	$T_j, T_{stg}$	$^\circ\text{C}$	-55 to +175

## Electrical Characteristics

PARAMETER	SYMBOL	UNIT	TEST CONDITIONS	Typ.	Max.
Forward voltage drop	$V_F$	V	$I_F=30A, T_j=25^{\circ}C$	1.54	1.70
			$I_F=30A, T_j=175^{\circ}C$	2.31	2.70
Reverse leakage current	$I_R$	$\mu A$	$V_R=1200V, T_j=25^{\circ}C$	1	60
			$V_R=1200V, T_j=175^{\circ}C$	40	-
Total capacitive charge	$Q_C$	nC	$V_R=800V, T_j=25^{\circ}C, Q_C=\int_0^{V_R} I_C(V)dV$	153	-
Total capacitance	C	$\mu F$	$V_R=0V, f=1MHZ$	2259	-
			$V_R=400V, f=1MHZ$	143	-
			$V_R=800V, f=1MHZ$	103	-
Capacitance Stored Energy	$E_C$	$\mu J$	$V_R=800V$	39.5	-

## Thermal Characteristics $T_a=25$ Unless otherwise specified

PARAMETER	SYMBOL	UNIT	VALUE
Thermal resistance	$R_{j-c}$	$^{\circ}C/W$	0.38

## Characteristics (Typical)

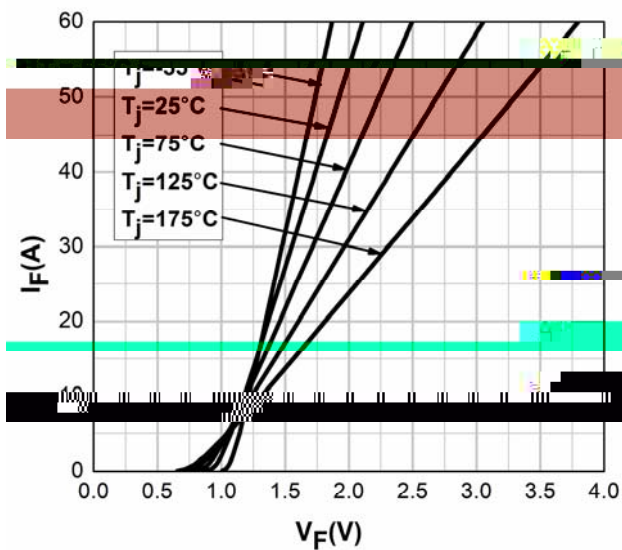

Figure 1. Forward Characteristics

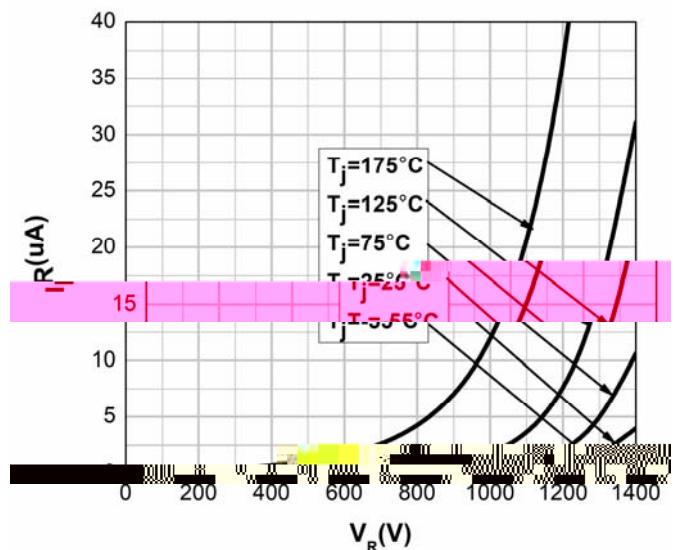

Figure2. Reverse Characteristic

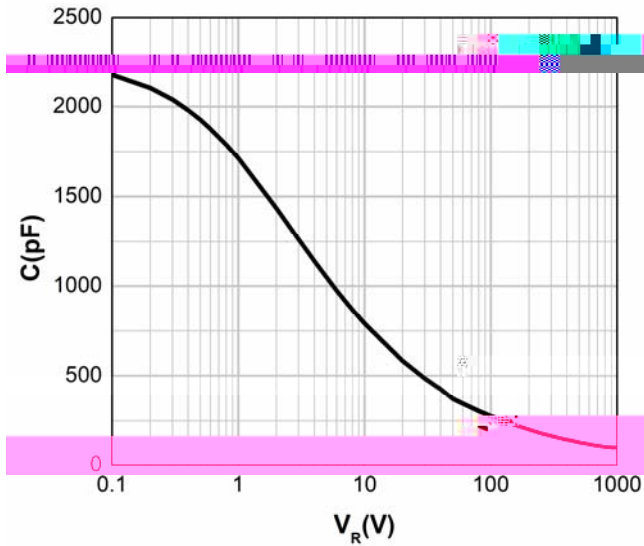

Figure 3. Capacitance vs. Reverse Voltage

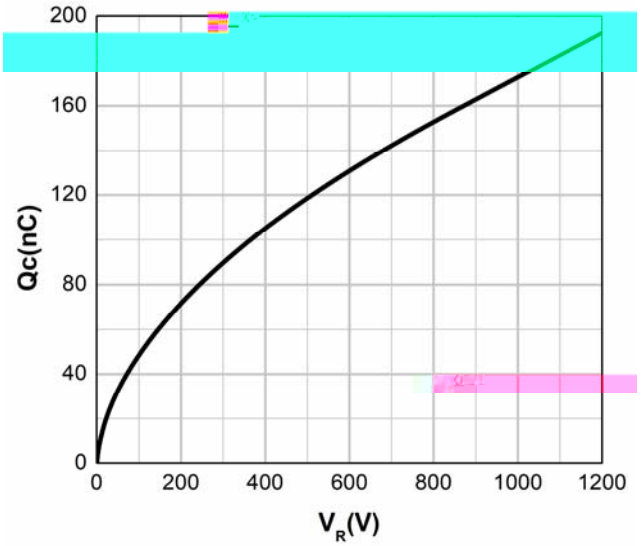

Figure 4. Total Capacitance Charge vs. Reverse Voltage

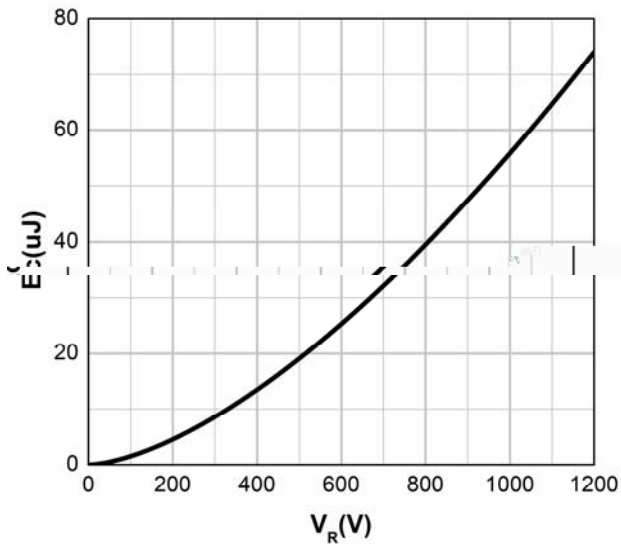

Figure 5. Capacitance Stored Energy

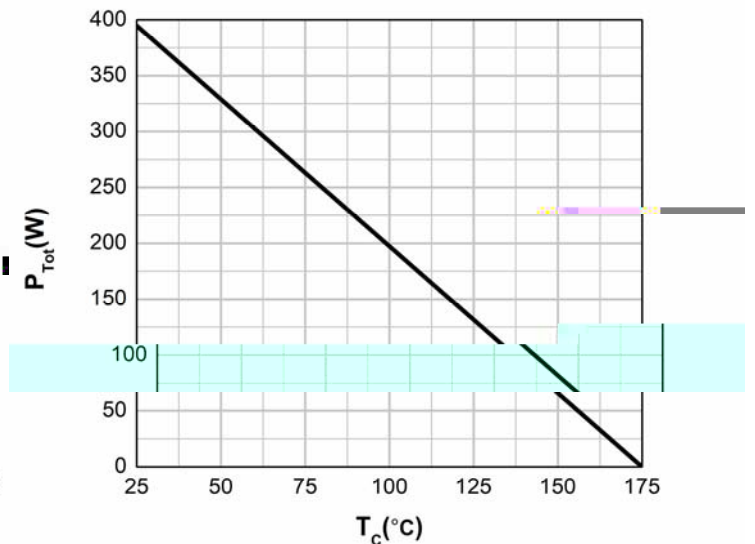

Figure 6. Power Derating

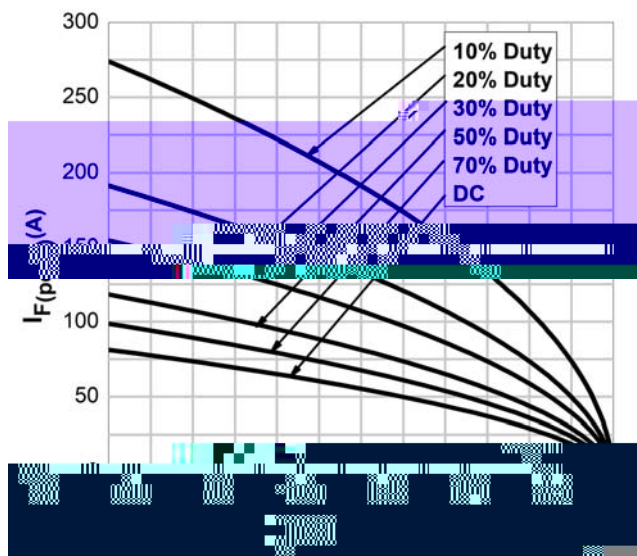

Figure 7. Current Derating

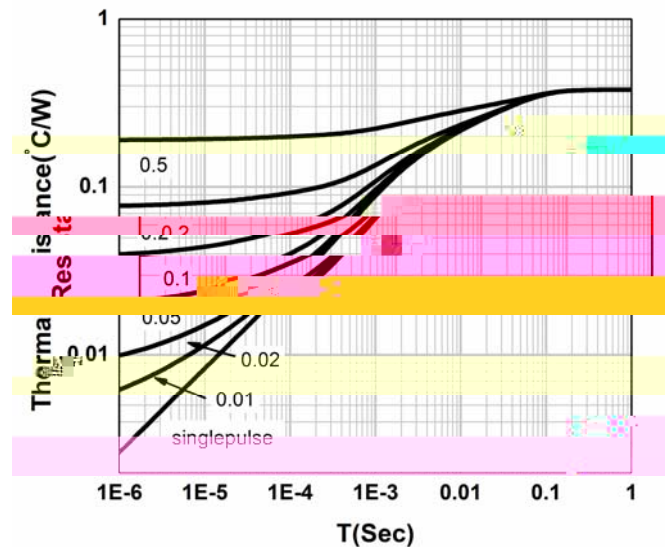
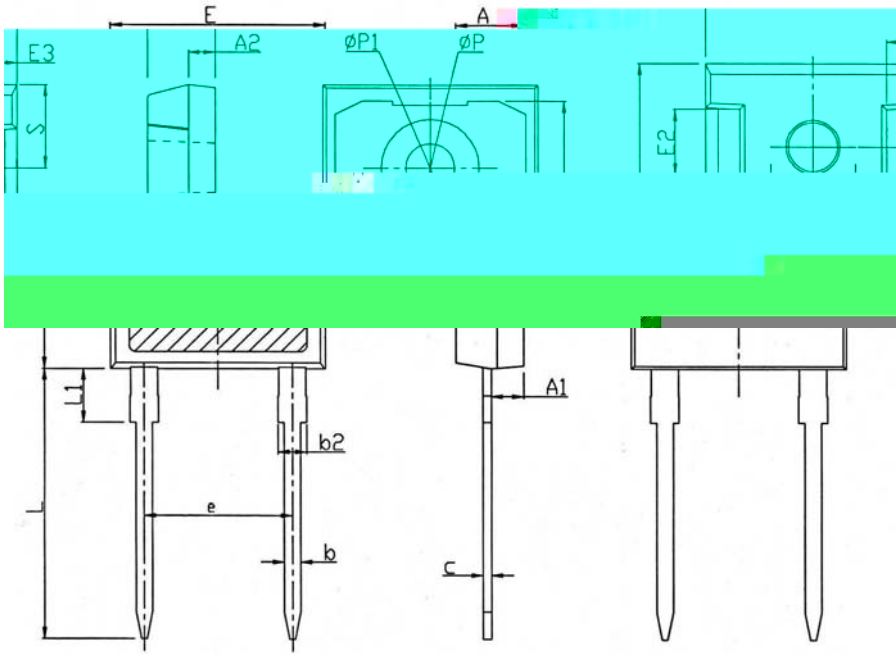

Figure 8. Transient Thermal Impedance

## Outline Dimensions



TO247-AC		
Dim	Min	Max
A	4.80	5.20
A1	2.21	2.61
A2	1.85	2.15
b	1.11	1.36
b2	1.91	2.21
c	0.51	0.75
D	20.70	21.30
D1	16.25	16.85
E	15.50	16.10
E1	13.00	13.60
E2	4.80	5.20
E3	2.30	2.70
e	10.88BSC	
L	19.62	20.22
L1	-	4.30
P	3.40	3.80
P1	-	7.30
S	6.15BSC	

**YJD112030NG1**