

## 规格承认书

—

\_\_\_\_\_

\_\_\_\_\_

prepare	
check	
approve	



TRX电容一级代理商  
深圳市弗瑞鑫电子有限公司

Add: 深圳市宝安区西乡大道302号金源商务大厦B座3楼

Tel: 0755-29563634

Fax: 0755-27447020



 <b>TRX</b> 专注电容器廿年	<b>SMD Y</b> <b>SMD Y1 a.c. ceramic capacitors</b>		
	/Number		/Date
	/Edition		/Page

 <p><b>TRX</b> 专注电容器廿年</p>	<b>SMD Y</b> <b>SMD Y1 a.c. ceramic capacitors</b>		
	/Number		/Date
	/Edition		/Page

**1. /Product Name**



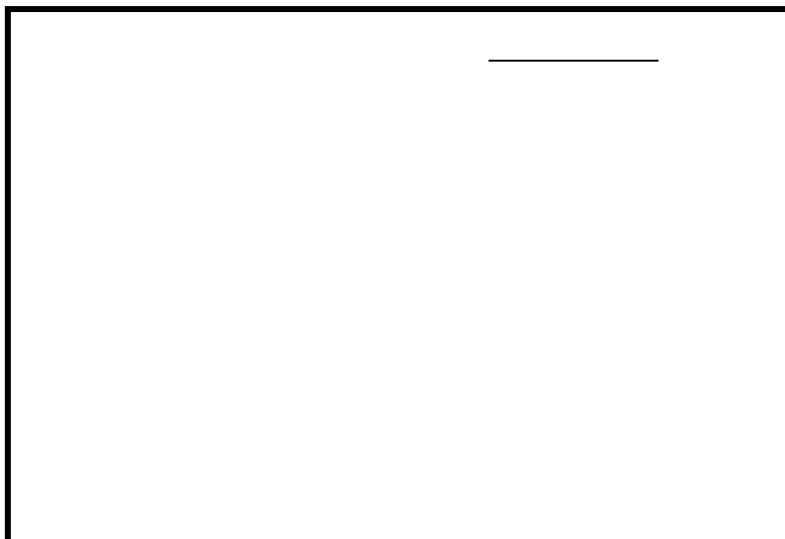
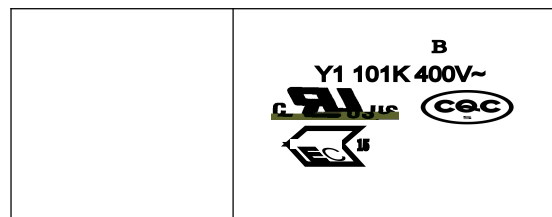

**T**   **M**   **Y1**   **101**   **K**  
 ①   ②   ③   ④   ⑤

①		
②		
③		
④		
⑤		

**2. /Product marking**



 <p><b>TRX</b> 专注电容器廿年</p>	<b>SMD Y</b> <b>SMD Y1 a.c. ceramic capacitors</b>		
	/Number		/Date
	/Edition		/Page

/Explanation	
	
	
	
	
	

3. /Date code

↓	↓				
		↓	↓		

**4. /Certificates**

certificates			

**5. / Product structure**

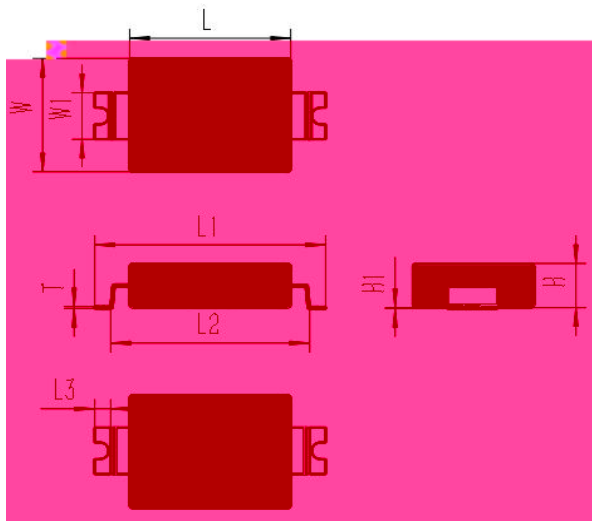

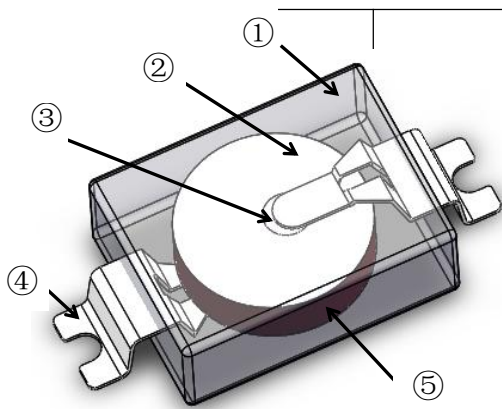
④		
⑤		



	<b>SMD Y</b> <b>SMD Y1 a.c. ceramic capacitors</b>		
	/Number		/Date
	/Edition		/Page

/

°  
°C

°

°

°

/

**7. / Performance and test methods**









**SMD Y**  
**SMD Y1 a.c. ceramic capacitors**

/Number

/Date

/Edition

/Page

		△	
		△	
		△	
		△	
		△	
		△	
		△	
		△	
		△	
		△	



 <b>TRX</b> 专注电容器廿年	<b>SMD Y</b> <b>SMD Y1 a.c. ceramic capacitors</b>			
	/Number		/Date	
	/Edition		/Page	





 <b>TRX</b> 专注电容器廿年	<b>SMD Y</b> <b>SMD Y1 a.c. ceramic capacitors</b>			
	/Number		/Date	
	/Edition		/Page	

11. /Prod

 <b>TRX</b> 专注电容器廿年	<b>SMD Y</b> <b>SMD Y1 a.c. ceramic capacitors</b>		
	/Number		/Date
	/Edition		/Page

**/inner-packaging**



标签



料号

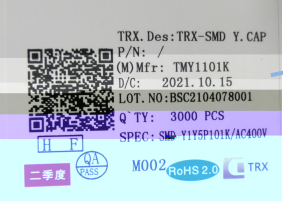

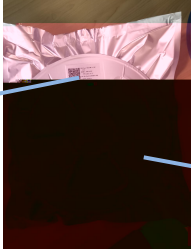

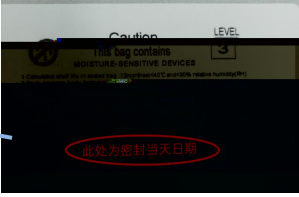

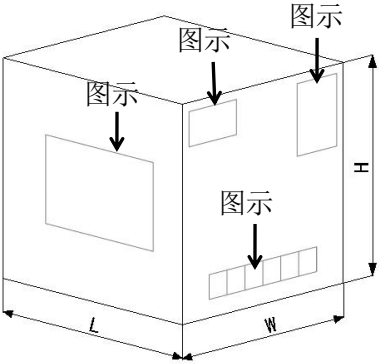

此处为密封当天日期

**/Outer-packaging**





图示 /



图示 /

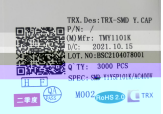

图示 /

**/Package sketch:**



/



/





**Remark**



	<b>SMD Y</b> <b>SMD Y1 a.c. ceramic capacitors</b>		
	/Number		/Date
	/Edition		/Page

**12. /Application notes**

①

②

③

④

⑤

⑥