



# 规格承认书

S

\_\_\_\_\_

\_\_\_\_\_

\_\_\_\_\_

\_\_\_\_\_

<b>JAENS</b>	
<b>SUNN</b>	



**TRX 特锐祥**  
专注电容器材料

**TRX 电容器一级代理商**

深圳市弗瑞鑫电子有限公司

Add : 深圳市宝安区西乡大道302号华丰金源商务大厦B座3楼

Tel : 0755-29563634

Emial : sales@frxelec.com





	<b>SMD- 1</b> <b>SMD 1 . .</b>		
	/N		/D
	/E		/P

 <b>TRX</b> 专注电容器廿年		SM
	/N	S
	/E	

1.

102 K







/N

SMD- 1  
SMD 1 . .

" .



	<b>SMD- 1</b> <b>SMD 1 . .</b>		
	/N		/D
	/E		/P

/

/

**7.                    /P**











 <b>TRX</b> 专注电容器廿年	<b>SMD- 1</b> <b>SMD 1 . .</b>		
	/N		/D
	/E		/P

			± ±
			± ±
			± ±
			± ±
			± ±

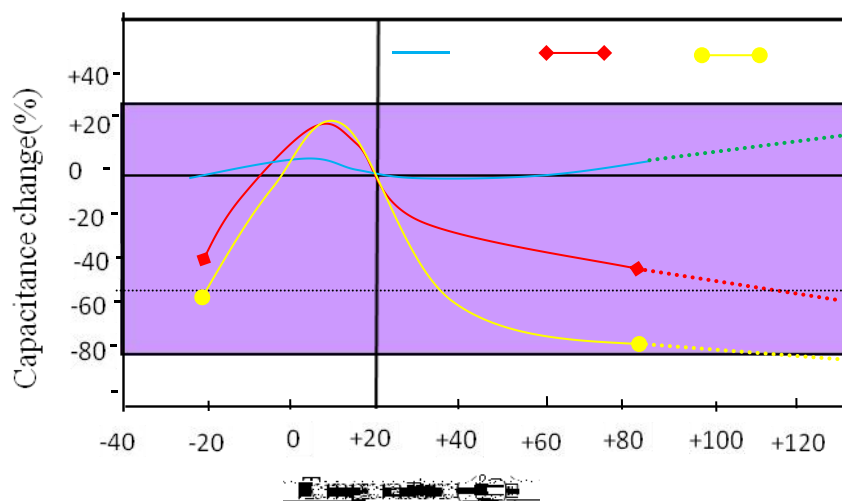
8. /C





 <b>TRX</b> 专注电容器廿年	<b>SMD- 1</b>		
	<b>SMD 1 . .</b>		
	/N		/D
		/P	

11. /P  
/

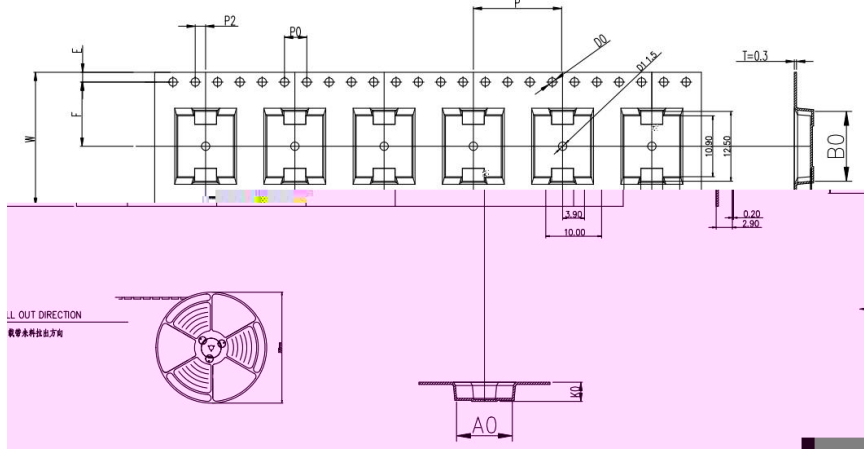

ITEM	W	A0	B0	K1	K0	P	F	E	D0	D1	P0	P2	T
DIM	24.0	$^{+0.30}_{-0.30}$	$^{+0.10}_{-0.10}$	$^{+0.10}_{-0.10}$	$^{+0.10}_{-0.10}$	$^{+0.10}_{-0.10}$	$^{+0.10}_{-0.10}$	$^{+0.10}_{-0.10}$	$^{+0.10}_{-0.00}$	$^{+0.10}_{-0.00}$	$^{+0.10}_{-0.10}$	$^{+0.10}_{-0.10}$	$^{+0.05}_{-0.05}$
ALTERNATE													

/

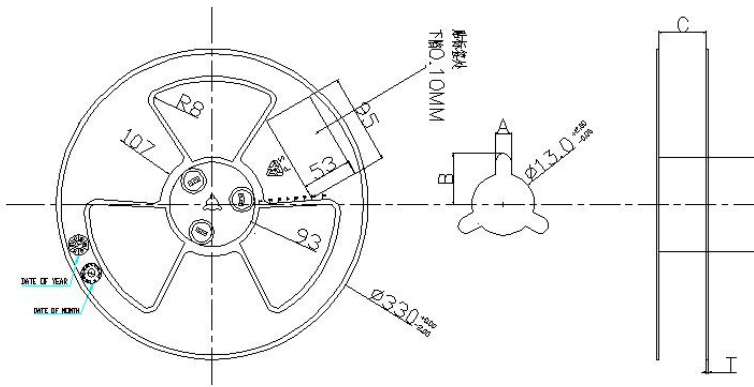

SPEC	A±0.3	B±0.5	C $^{+0.5}_{-0.0}$	D±0.5	T±0.2
24	2.3	10.75	24.4	Ø97	2.2

/

Item	Data	Remark
Cover tape adhesion	10 ~ 100g	Carrier tape and cover tape open angle 165 ~ 180° F=300± 5mm/minute

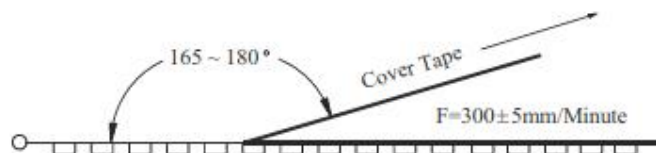





SMD- 1  
SMD 1 . .

/N

/D

/E

/P

/ -

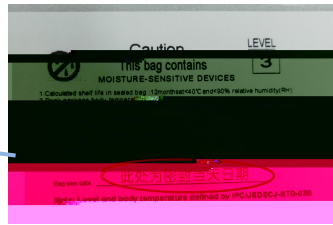
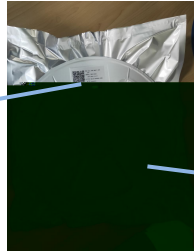
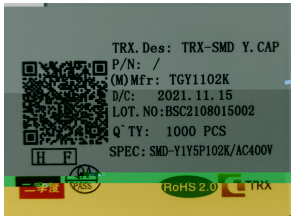
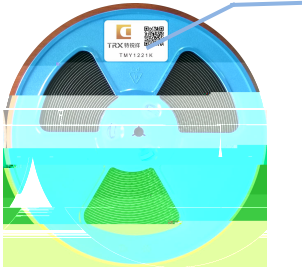

/O -

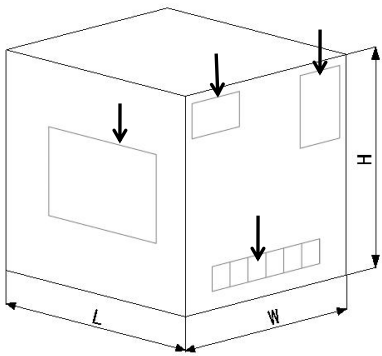

/

/

/

/P

:



/

/

" "

R

