



TRX 特锐祥
专注电容器廿年

	SMD- 1 SMD 1 . .		
	/N		/D
	/E		/P

/ I

/ II

TR SMD- 1.CAP
C R T.C.D (U : F

T.C						

	SMD- 1 SMD 1 . .		
	/N		/D
	/E		/P

1.

N

102 K

2.

×



 TRX 专注电容器廿年	SMD- 1		
	SMD 1 . .		
	/N		/D
/E		/P	

4. /C

[]			

5. /P

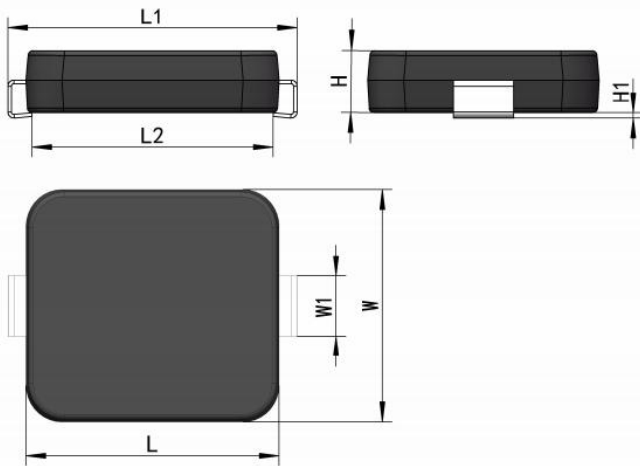

[]			

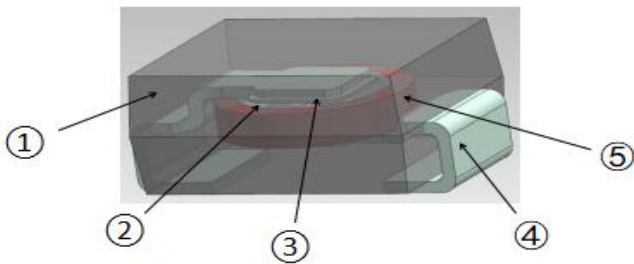

[]		



/N

SMD- 1
SMD 1 . .

 TRX 专注电容器廿年	SMD- 1		
	SMD 1 . .		
	/N		/D
/E		/P	

/

/

7. /P



SMD- 1
SMD 1 . .

/N

/D

/E

/P

			<table border="1" style="width: 100%; text-align: center;"> <tr> <td></td><td></td><td></td><td></td><td></td><td></td> </tr> <tr> <td></td><td></td><td></td><td></td><td></td><td></td> </tr> </table>												
			±												



SMD- 1
SMD 1 . .

/N

/D

/E

/P

				±	

/N

/D

/E

/P

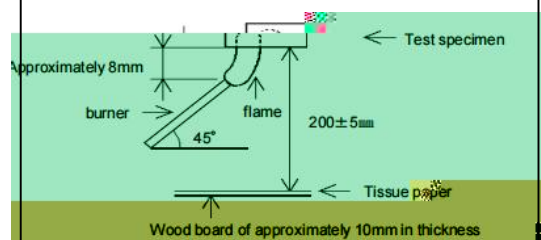

 TRX 专注电容器廿年	SMD- 1		
	SMD 1 . .		
	/N		/D
/E		/P	

			± ±
			± ±
			±
			± ±
			± ±
			±

8. /C

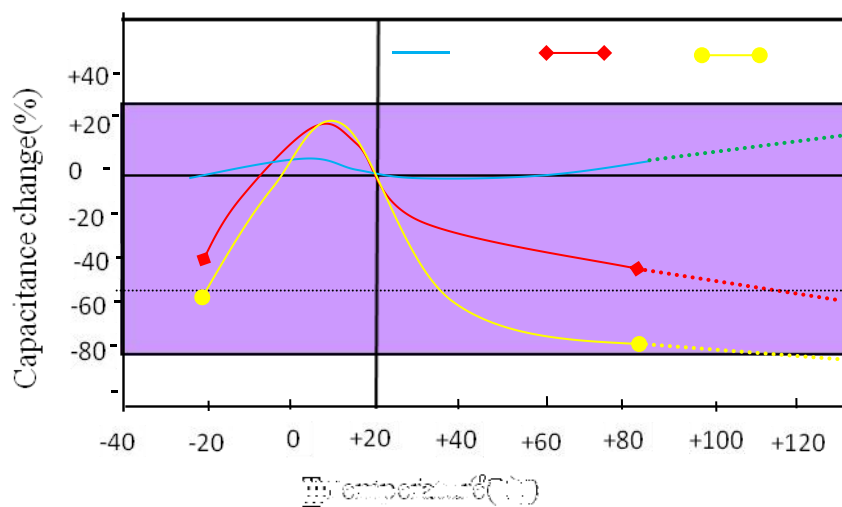

 TRX 专注电容器廿年	SMD- 1 SMD 1 . .			
	/N		/D	
	/E		/P	

9.

/C



10.

/S

/

11. /P

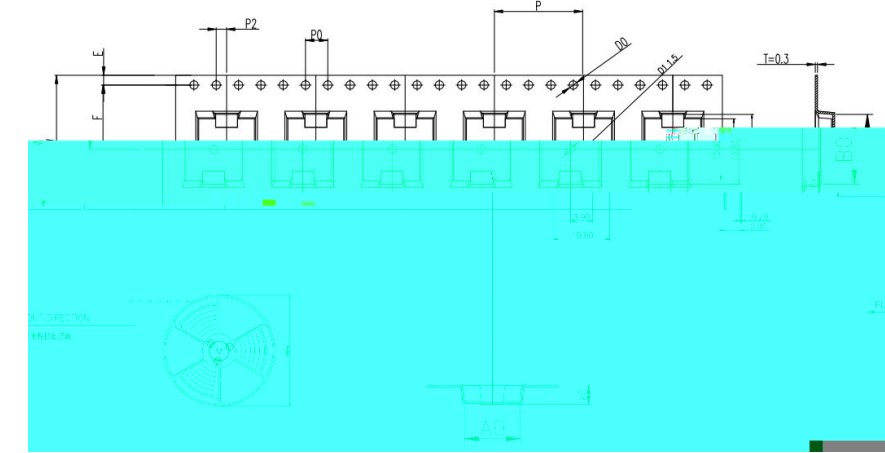

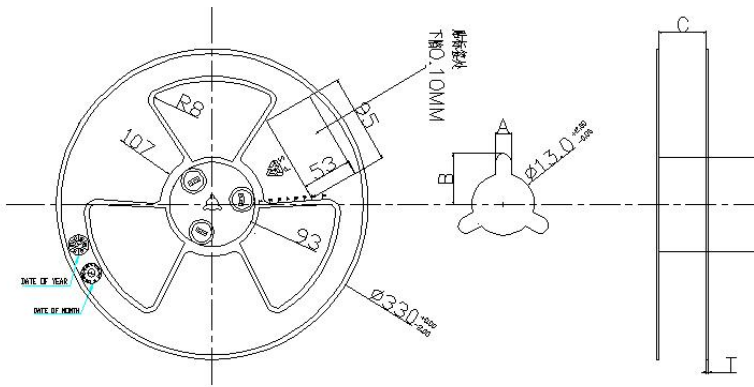

ITEM	W	A0	B0	K1	K0	P	F	E	D0	D1	P0	P2	T
DIM	24.0	$+0.30$ -0.30	$+0.10$ -0.10	$+0.10$ -0.10	3.45	$+0.10$ -0.10	$+0.10$ -0.10	$+0.10$ -0.10	± 0.00	$+0.10$ -0.10	$+0.10$ -0.10	$+0.10$ -0.10	$+0.05$ -0.05

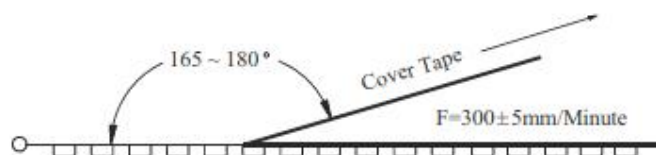

SPEC	A±0.3	B±0.5	C $+0.5$ -0.0	D±0.5	T±0.2
24	2.3	10.75	24.4	Ø97	2.2

Item	Data	Remark
Cover tape adhesion	10 ~ 100g	Carrier tape and cover tape open angle 165 ~ 180° F=300± 5mm/minute



 TRX 专注电容器廿年	SMD- 1		
	SMD 1 . .		
	/N		/D
		/P	

/ -











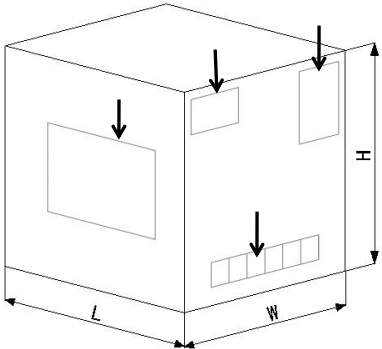

/O -







/P :









" "

R

